

PRODUCTS 2019

Fire safety from Autronica Fire and Security

Division land



CONTENTS

AutroSafe fire detection system.....	4	Detectors for special requirements.....	42
System panels	6	Aspirating detectors	43
System panel kits	7	Accessories.....	44
Loop panels	8	Piping – halogen free.....	44
Modules.....	9	Flame detectors.....	49
Communication.....	11	Accessories.....	49
Printer	12	Test equipment.....	50
Engineering.....	12	Beam detectors.....	51
Service tools.....	12	Accessories.....	51
OPC server	13	Alarmline linear heat detection.....	54
		Accessories.....	54
Autroprime fire detection system.....	14	AutroXT extinguishant control system.....	56
Panels	15	Panels.....	57
Printer	15	Accessories.....	57
Modules.....	16		
Service and configuration tool.....	16	AutroMaster presentation system	58
		AutroMaster editions.....	59
Fire detection system accessories.....	17	AutroMaster V	60
Cabinets and racks.....	17	AutroMaster 4	60
Mounting and front plates.....	18	Software modules - AutroMaster 4.....	60
Switches and converters	19	Engineering/Configuration	61
Batteries.....	21	Hardware	61
Power supply units	22		
Relays.....	22	AutroVoice voice alarm system	62
Surge protection.....	22	AutroVoice miniVES	63
Door magnets	23	Microphones	64
		Tilbehør.....	64
Loop units	24	AutroVoice MULTIVES	65
Input and output units	25	Control units	66
Detectors.....	28	Control unit elements.....	66
Manual call points / release stations	29	Microphones and accessories	68
Control units	32	Power amplifiers.....	69
Alarm units.....	33	Power supply modules.....	70
Accessories for loop units	38	Modules SFP.....	70
Test/measuring equipment	39	Network switches.....	71
		Miscellaneous	71
		Loudspeakers.....	72

Stringent control throughout Autronica Fire and Security AS assures the excellence of our products and services. For a complete overview of our approvals, go to www.autronicafire.com.

Main office:
Autronica Fire and Security AS
Bromstadvegen 59
NO-7047 Trondheim
NORWAY

Contact:
+47 90 90 55 00
info@autronicafire.no
www.autronicafire.com

Service and support:
+47 915 09753
08:00 – 16:00 CET weekdays





AutroSafe fire detection system

For large and complex buildings

AutroSafe is our high-end fire detection system for large and complex buildings. Since the launch in 1999, it has proven its unique stability and reliability in more than 15 000 installations worldwide, from hotels to cruise ships to drilling platforms.

AutroSafe 4 provides advanced functionality for a wide range of applications. The system is designed to meet all requirements in the high-end segment of the onshore, maritime and offshore market, and is certified according to European directives (CPD) requiring EN 54



compliance. The system is also pending a Factory Mutual (FM) approval according to NFPA 72.

Reliable communication is paramount to your safety. That's why we're adding AutroNet to the AutroSafe system, an innovative network solution safeguarding communication between panels. AutroNet ensures a redundant and high-speed network expanding the reach of the AutroSafe system even further. The system can be set up either in a star or ring network, depending on your needs.

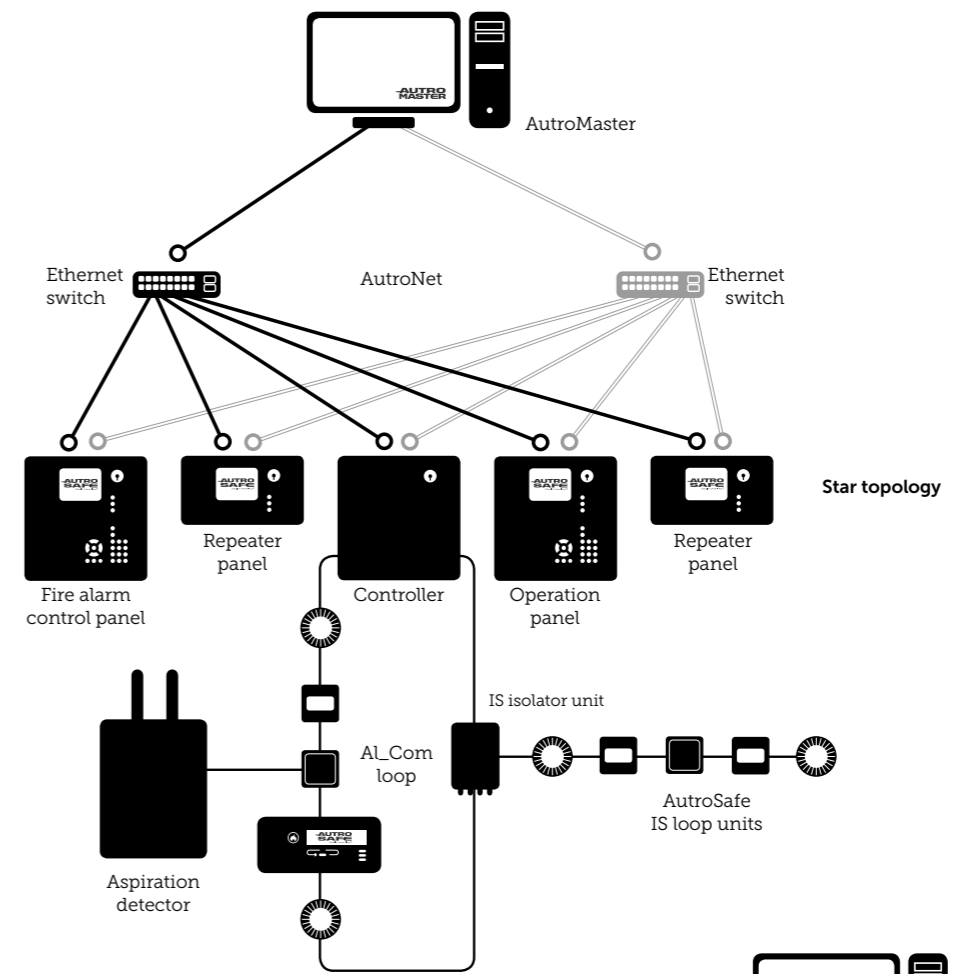



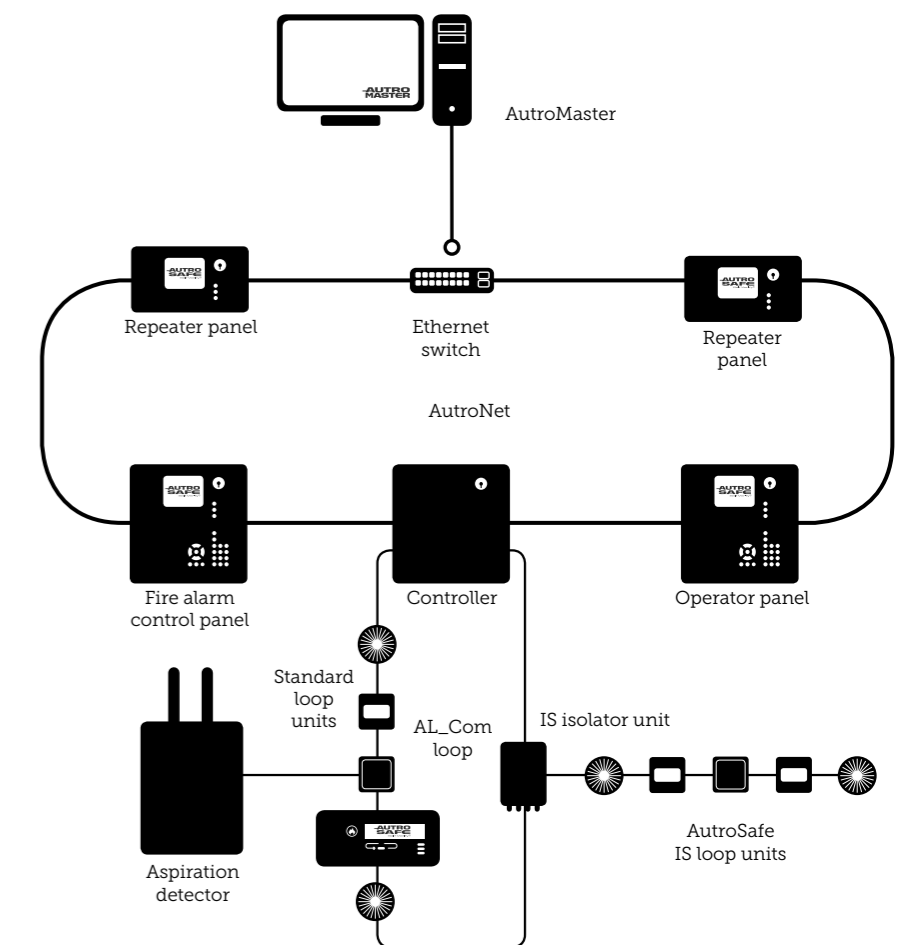

Star topology



Ring topology

System panels

Image	Part number	Description	Dimensions H x W x D (mm)	Notes
	116-BS-420/XX	Fire alarm control panel	350 x 350 x 161 Flush mounting depth: 148	Can be used as a stand-alone panel as well as part of a network system. All operations, alarm management, indications and other functions within an operation zone are controlled and handled by the panel. Loop driver, input and output modules can be connected. An integrated AutoFieldBus interface makes it possible to connect AutoFieldBus equipment to the panel. Equipped with 2 x loop driver BSD-310. Additional modules (page 8) can be added.
	116-BC-420/XX	Controller	350 x 350 x 161	Controller for connection of loop driver modules as well as input and output modules. An integrated AutoFieldBus interface makes it possible to connect AutoFieldBus equipment to the panel. Equipped with 2 x loop driver BSD-310. Additional modules (page 8) can be added.
	116-BC-440	Controller rack unit	3U x 12HP x 200	Serves as a connection unit for the detection loop, alarm sounders, controls and inputs. It is a variant of the BC-420 prepared for rack installations. Together with the I/O modules the unit will have the full functionality of the BC-420. Equipped with 2 Ethernet ports, one AutoFieldBus port and one serial port.
	116-BS-430/XX	Operator panel	350 x 350 x 84	The operator panel controls and handles all operations, alarm management, indications and other functions within an operation zone. No loop driver, input or output modules can be connected to this panel.
	116-BU-BV-420/XX	Repeater panel	195 x 350 x 84	Dip switches on the panel control the panel function: As a fire brigade panel it can operate alarms within one or more operation zones. As an information panel no operation of alarms are available. The information panel provides information from one or more operation zones.
	116-BP-405	Power cabinet	420 x 346 x 146	Includes a 5 A power pack (BPS-405) which provides six 24 VDC / 2 A outputs. The input voltage is 115/230 VAC and the total maximum power available is 24 VDC / 5 A. An integrated AutoFieldBus interface makes it possible for the power pack to communicate (send fault messages) with the BS-420 or BC-420 panel. Space for two 12 V / 18 Ah batteries (not included).

XX can be replaced by the following codes
GB = English
NL = Dutch

System panel kits

For engineering purposes, we have established kits to be equipped according to specifications.



The BS-420 and BC-420 panels have space for up to 12 modules totally inside the cabinet. An AL_Com+ stack can contain up to six loop driver modules (BSD-3xx). By using AutoFieldBus, an additional AL_Com+ stack (with up to six additional loop driver modules) can be added to the system.

Image	Part number	Description	Including	Options
	116-KIT-BS-420	Fire alarm control panel kit	Panel front BSV-420 Cabinet UEA-400 Power supply module BSS-310A Communication module BSL-310 Text foil E-2879/XX*	Loop driver module BSD-310 Loop driver module H.P. BSD-311 BS-100 loop driver module BSD-330 Output module BSB-310A Output module BSJ-310 Input module BSE-310 Input module BSE-320 Dual power monitoring module BSS-311
	116-KIT-BC-420	Controller kit	Panel front BCV-420 Cabinet UEA-400 Power supply module BSS-310A Communication module BSL-310 Text foil E-2880/XX*	Loop driver module BSD-310 Loop driver module H.P. BSD-311 BS-100 loop driver module BSD-330 Output module BSB-310A Output module BSJ-310 Input module BSE-310 Input module BSE-320
	116-KIT-BS-430	Operator panel kit	Panel front BSV-420 Cabinet UE-1488 Text foil E-2879/XX*	
	116-KIT-BU-BV-420	Repeater panel kit	Panel front BUV-420 Cabinet UE-1489 Text foil E-2880/XX*	

*: Available languages, replace XX with one of the following codes:
GB = English IS = Icelandic NL = Dutch
E = Spanish BR = Portuguese DK = Danish
F = French PL = Polish S = Swedish
H = Hungarian RK = Russian N = Norwegian
I = Italian SF = Finnish

Loop panels

Loop-powered panels are a unique addition to our system panel BU/BV-420, providing our customers a number of advantages: Quicker installation, reduced cabling and cost, and lowered system complexity. A detection loop can accommodate up to eight loop panels.

Image	Part number	Description	Dimensions H x W x D (mm)	Current consumption	Notes
	116-KIT-BU-110	Fire brigade loop panel kit*	154 x 310 x 45	<1 mA (idle) 6 mA (max)	Enables silencing the panel's internal buzzer, silencing alarms, and resetting the system. Alarms only are shown in the display.
	116-BU-110GB	Fire brigade loop panel, English text			
	116-BU-110NL	Fire brigade loop panel, Dutch text			
	116-KIT-BV-110	Information loop panel kit*	154 x 310 x 45	<1 mA (idle) 6 mA (max)	Indication device only. Provides information related to the defined operation zone(s).
	116-BV-110GB	Information loop panel, English text			
	116-BV-110NL	Information loop panel, Dutch text			

*: Please specify language when ordering:
 E = Spanish IS = Icelandic SF = Finnish
 F = French BR = Portuguese DK = Danish
 H = Hungarian PL = Polish S = Swedish
 I = Italian RK = Russian N = Norwegian

Modules

In addition to loop driver modules BSD-310, BSD-310N and BSD-311, as well as the mandatory power supply module BSS-310A and communication module BSL-310, AutroSafe features input and output modules for different applications (monitored alarm loops, servicing relays and LEDs, control inputs, etc.)

The modules have the same format, mount onto the panels' DIN-mounting rail and plug into one another.

Important note on module capacity.

Each fire alarm panel/controller contains a power supply module BSS-310A and a communication module BSL-310.

The BS-420 and BC-420 panels have space for up to 12 modules totally inside the cabinet.

An AL_Com+ stack can contain up to six loop driver modules (BSD-3xx)

By using AutoFieldBus, an additional AL_Com+ stack (with up to six additional loop driver modules) can be added to the system.







Image	Part number	Description	Monitored inputs	Monitored outputs	Total inputs	Total outputs	Monitors short circuits	Ensures loop communication	Zone 2 only	Amplified power output	Galvanically insulated inputs/outputs	Max. per panel	Notes
	116-BSB-310A	Output module	•	0	4	•							Requires external 24V
	116-BSD-310	Loop driver module			-	-	•	•				6/12	Max. 127 loop units
	116-BSD-310/N	Loop driver module			-	-	•	•	•			6/12	Max. 127 loop units
	116-BSD-311	Loop driver module H.P.			-	-	•	•	•				

Image	Part number	Description	Monitored inputs	Monitored outputs	Total inputs	Total outputs	Monitors short circuits	Ensures loop communication	Zone 2 only	Amplified power output	Galvanically insulated inputs/outputs	Max. per panel	Notes
	116-BSD-330	BS-100 loop driver module			-	-	•	•				8	If more than 3 modules are installed, an additional power supply unit BSS-310A is required
	116-BSE-310	Input module	•		4	0							
	116-BSE-320	Input module			8	0				•			
	116-BSJ-310	Output module			0	8							Open transistor outputs
	116-BSS-310A	Power supply module										3	
	116-BSS-311	Dual power monitoring module										2	

Communication

Image	Part number	Description
	116-BSD-321/1	AutoFieldBus protocol converter Interface between AutoFieldBus and AL_Corn+. Enables communication between all AL_Corn+ modules in an AL_Corn+ stack connected to AutoFieldBus. The module enables AutoSafe Dual Safety configuration, with both ordinary AL_Corn communication and AutoFieldBus.
	116-BSL-310	AutoSafe communication module, serves as an interface for the common internal communication line between all the different I/O modules. Part of the fire alarm control panel.
	116-BSL-321	Multi mode fibre optic converter Amplifier for AUTROLON/AutoFieldBus networks, which acts as a fibre-optic modem. The converter ensures reliable communication for distances of up to 3000 m. Uses multi mode (62.5/125 µm or 50/125 µm) fibre-optic cable. Ingress Protection level: IP20
	116-BSL-322	Single mode fibre optic converter Amplifier for AUTROLON/AutoFieldBus networks, which acts as a fibre-optic modem. The converter ensures reliable communication for distances of up to 15000 m. Uses single-mode (9/125 µm) fibre-optic cable. Ingress Protection level: IP20
	116-BSL-325	AUTROLON/AutoFieldBus communication amplifier Amplifier for communication signals on networks. The amplifier ensures reliable communication over large distances. The amplifier increases max. cable length from 1000 m to 2800 m. Ingress Protection level: IP20
	116-BSL-337	AutoSafe BU-70 interface module Enables the connection of BU-70/BU-100/BU-101 to AutoSafe. This is a simple, cost effective way to upgrade BS-100 systems to AutoSafe. The RS232/20 mA current loop converter BSL-12/2 must be used to convert RS232 to 20 mA current loop communication. Ingress Protection level: IP20

Printer

Image	Part number	Description
	116-BUP-400	Printer unit for AutroSafe 4, including 1 roll of printer paper.
–	116-1712-012.0001	Printer paper 57 x 46 x 13 mm / 25 m

Engineering

Part number	Description
116-PROG-AUTROSAFE	Customer specific software for AutroSafe
116-TXT-AUTROSAFE	Customer text/controls

Service tools

Image	Part number	Description
	116-WAS-2000	AS2000 loop diagnostic tool in casing, including PC cable.
–	116-XJA-027	Connection cable for AS2000; for connection between computer and fire alarm panel
–	116-XGE-1/10-110	Ribbon cable for connection of BSF-310/BSA-400 to BSL-310. 110 cm. Order only.
–	116-XGE-1/10-200	Ribbon cable for connection of BSF-310/BSA-400 to BSL-310. 200 cm.
–	116-XL-073	Conversion cable from AutroSafe 3 to AutroSafe 4

OPC server

With the AutroSafe OPC server several fire detection systems and other control systems can communicate. The solution improves the compatibility between the AutroSafe and surveillance systems from other manufacturers.

Part number	Description
116-AS-OPC-SERVER/CD1	AutroSafe OPC Server CD V1.2 incl. access code for access level 1. Includes read access to all status information for detectors, output and alarm devices. This level of license will also make it possible to send (write) Silence, Reset and SetTime commands to the AutroSafe system. Within this level you can also Disable/Enable detectors.
116-AS-OPC-SERVER/CD2	AutroSafe OPC Server CD V1.2 incl. access code for access level 2. Includes all functionality in level 1, plus the possibility to Activate/Deactivate and Enable/Disable outputs and alarm devices via OPC write commands.
116-AS-OPC-SERVER/CD3	AutroSafe OPC Server CD V1.2 incl. access code for access level 3. Includes all functionality in level 1 and 2. This level also provides additional information for points, for example AMEAS, Temp, Smoke, Alarm limits and Engineering values.



Autroprime fire detection system

Fire detection made easy

For small-to-medium sized installations, Autroprime® brings simplicity, quality and extensive functionality in one integrated system, providing safety and economy in a complete package.

Simplicity is the key feature for this system. Through the entire process, from installation and commissioning, via use, to service, Autroprime is designed with a focus on simplicity. Through our SelfVerify technology, the system ensures the daily maintenance routines by itself.

Autroprime® is our easy, reliable and flexible fire detection system, providing a high-tech, low-cost alternative for fire detection in applications such as daycare centres, museums, small hotels, office buildings, etc. The system is approved according to international standards, providing the efficient and reliable detection our customers have come to expect.

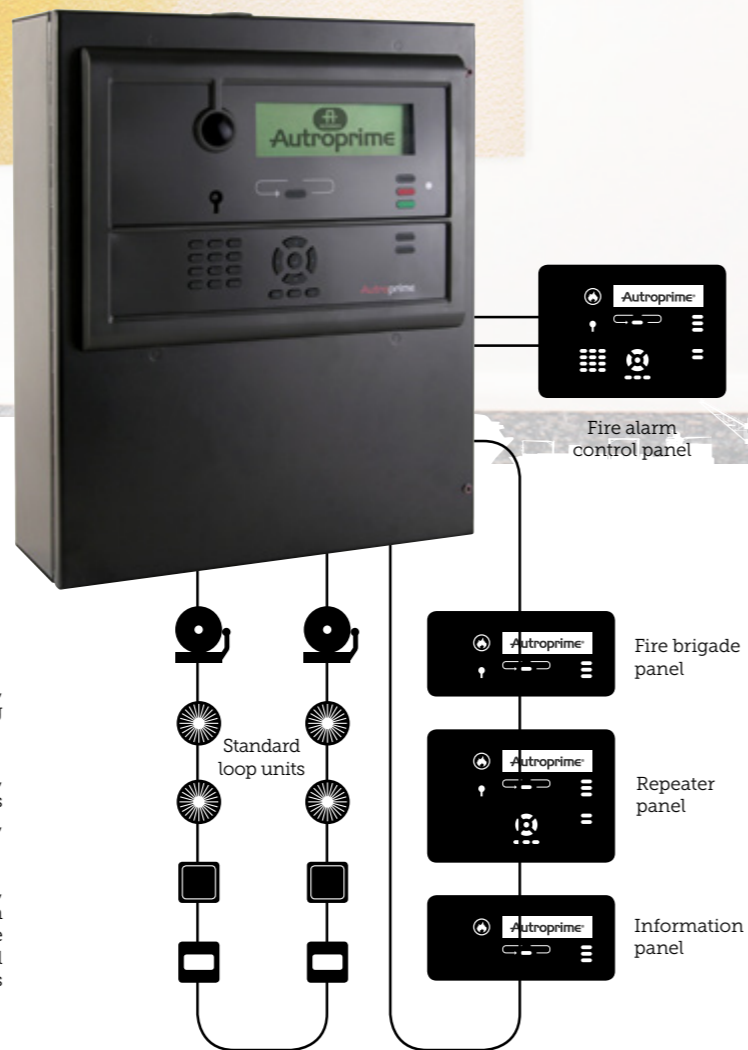

Panels

The Autroprime system allows for a combination of maximum 8 panels and mimic drivers on a redundant panel bus

Image	Part number	Description	Dimensions H x W x D (mm)	Notes
	116-BS-200	Fire alarm control panel	420 x 346 x 140	Full fire detection system with 2 loop drivers each controlling 127 devices. The operator panel may be mounted remotely with redundant connections both for signal and power. Max. 4 loops.
	116-BS-211	Repeater panel	310 x 220 x 45	Helps users manage alarms and other events. Panel bus included
	116-BU-210	Fire brigade panel	154 x 310 x 45	Showing alarms only. The user may mute the internal buzzer, silence sounders/bells and reset the system. Panel bus included.
	116-BV-210	Information panel	154 x 310 x 45	Provides all information, but does not allow handling of events. Panel bus included
	116-BUR-200	Mimic driver	181 x 125 x 40	Panel bus included

Printer

Image	Part number	Description
	116-BUP-200	Printer unit for Autroprime
-	116-1712-012.0001	Printer paper 57 x 46 x 13 mm / 25 m

Modules

Image	Part number	Description
	116-BSD-200A/PACK	Autroprime loop extension pack, 2 loops

Service and configuration tool

Part number	Description
116-AUTROCLIENT	AutoClient, latest version

Fire detection system accessories





In order to project our fire detection system to any application, we provide a wide range of accessories such as cabinets, racks, mounting equipment, batteries etc.

Cabinets and racks

Image	Part number	Description	System	Dimensions H x W x D (mm)	Capacity
	116-BV-311	Cabinet for evacuation and emergency documents	AutroSafe	402 x 347 x 75	
	116-UEA-323/1	Cabinet for flush mounting BS-420/BC-420	AutroSafe	Flush mounting: 320 x 320 x 140	
	116-UE-1710	Battery shelf	19" rack	398 x 190 x 174	2 x 12 V / 36 Ah or 1 x 12 V / 65 Ah battery
	116-US-820/1	Document holder with logo	Both		
	116-6800-003.	Renag key safe, lacquered	Both		
	116-6745-012.	Standard fire key for panel door (plastic)			

Rittal cabinets available on request.

Mounting and front plates

Image	Part number	Description	Height (mm)	Module height*	Notes
-	116-UB-383	19" subrack 160 mm, Europe		3	
	116-UE-474	Mounting plate, no cutouts	534	12	For UAK-2 (back wall)
	116-UW-1518	Mounting plate	622 x 455	-	For mounting AutoSafe 4 front panel on double BS-100 cabinet
-	116-UW-1516/1	Dummy plate 19", 12HP	128	3	For BC-440
	116-UW-1454	Mounting plate for mounting panel front in 19" rack	399	9	For BS-420/-430 and BC-420
	116-UW-1482	Mounting kit for 19" cabinet/rack	263	6	For BU-BV-420 cabinets

*: Module height (h) = 44.5 mm.

Switches and converters



A network solution (AutoNet) with more than two panels demands the use of switches. Fibre converters are utilized to extend your network where fibre is available. VDSL converters are utilized to make use of existing copper wiring when upgrading old systems. Only the listed Ethernet switches and converters are approved and supported by Autronica Fire and Security AS. The type and number of switches/converters depend on the installation/network construction (no. of panels and distance between panels and switches/converters).

Image	Part number	Description*	Current consumption (max.) @ 24 VDC	RJ45 ports	Fibre optic ports**	Operating temperature
	116-5151-030.2127	FL switch SFNT 5TX	120 mA	5	-	-40 - 75 °C
	116-5151-030.2128	FL switch SFNT 4TX/FX	160 mA	4	1 MM (SC)	-40 - 75 °C
	116-5151-030.2129	FL switch SFNT 8TX	153 mA	8	-	-40 - 75 °C
	116-5151-030.2130	FL switch SFNT 7TX/FX	175 mA	7	1 MM (SC)	-40 - 70 °C
	116-5151-030.2131	FL switch LM 5TX	150 mA	5	-	-40 - 70 °C
	116-5151-030.2132	FL switch LM 4TX/FX	380 mA	4	1 MM (SC)	-40 - 70 °C
	116-5151-030.2133	FL switch LM 4TX/2FX	400 mA	4	2 MM (SC)	-40 - 70 °C

* SFNT = Standard Function, Narrow housing, high Temperature range
 LM = Lean Managed
 SFNB = Standard Function, Narrow housing, Basic entry level
 SFN = Standard Function, Narrow housing

** MM = Multi Mode
 SM = Single Mode
 SC = Square Connector
 (Set and Click, Stab and Click, Standard Connector)

Image	Part number	Description*	Current consumption (max.) @ 24 VDC	RJ45 ports	Fibre optic ports**	Operating temperature
	116-5151-030.2134	FL switch LM 4TX/FX SM	380 mA	4	1 SM (SC)	-40 - 70°C
	116-5151-030.2135	FL switch LM 4TX/2FX SM	400 mA	4	2 SM (SC)	-40 - 70°C
	116-5151-030.2136	FL switch SFNB 5TX	180 mA	5	-	-10 - 60°C
	116-5151-030.2137	FL switch SFNB 8TX	138 mA	8	-	-10 - 60°C
	116-5151-030.2138	FL switch SFN 4TX/FX	140 mA	4	1 MM (SC)	0 - 60°C
	116-5151-030.2139	FL switch SFN 7TX/FX	190 mA	7	1 MM (SC)	0 - 60°C
	116-5151-030.2140	FL switch SFN 6TX/2FX	230 mA	6	2 MM (SC)	0 - 60°C
	116-5151-030.2142	FL switch SFNB 4TX/FX SM 20	185 mA	4	1 SM (SC)	0 - 60°C

Image	Part number	Description*	Current consumption (max.) @ 24 VDC	RJ45 ports	Fibre optic ports**	Operating temperature
	116-5151-030.3001	Jetcon 1301-S single mode fibre converter	150 mA	1	1 SM (SC)	-40 - 70°C
	116-5151-030.3002	Jetcon 1301-M multi mode fibre converter	150 mA	1	1 MM (SC)	-40 - 70°C
	116-5151-030.3003	Jetcon 2502 ethernet/VDSL 2 converter	210 mA	2	-	-40 - 70°C

* SFNT = Standard Function, Narrow housing, high Temperature range
 LM = Lean Managed
 SFNB = Standard Function, Narrow housing, Basic entry level
 SFN = Standard Function, Narrow housing

** MM = Multi Mode
 SM = Single Mode
 SC = Square Connector
 (Set and Click, Stab and Click, Standard Connector)

Batteries

Autronica Fire and Security AS offers accumulator batteries for every Autronica fire detection system. Generally, 24 VDC back-up is used, requiring two batteries per panel. All batteries are sealed and can be placed in cabinets.

Part number	Voltage	Weight	Dimensions LxWxH (mm)	Notes
116-4160-000.1065	6 V / 7 Ah	1.08 kg	151 x 34 x 94	AutroSense
116-4160-005.0002	12 V / 1.2 Ah	0.52 kg	97.5 x 43.5 x 53	WAS-2000
116-4160-005.	12 V / 2.3 Ah	0.89 kg	179 x 35 x 61,5	
116-4160-005.0003	12 V / 3.2 Ah	1.25 kg	134 x 67 x 61	
116-4160-001.	12 V / 7 Ah	2.14 kg	151 x 65 x 95	
116-4160-005.0001	12 V / 12 Ah	4.0 kg	151 x 98 x 99	
116-4160-002.	12 V / 18 Ah	5.9 kg	181 x 76 x 167	AutroSafe
116-4160-003.	12 V / 27 Ah	8.7 kg	166 x 175 x 125	
116-4160-004.	12 V / 42 Ah	13.8 kg	196 x 163 x 174	
116-4160-006.	12 V / 65 Ah	20.1 kg	327 x 173 x 167	
116-4160-006.0003	12 V / 100 Ah	30.5 kg	327 x 172 x 216	Order only

Power supply units

Part number	Description	Output voltage
116-BPS-405/BOXED	Power supply unit for AutoSafe 4	24 VDC / 5 A
116-BPS-410/BOXED	Power supply unit for AutoSafe 4	24 VDC / 10 A
116-BPS-410/115/BOXED	Power supply unit for AutoSafe 4, 115 VAC	24 VDC / 10 A
116-4550-012.2410	Power supply with fault output for all systems	24 VDC / 10 A
116-4550-004.0001	Power supply for Autroprime	24 VDC / 5 A
116-4660-009.0004	DC/DC converter	24 VDC / 3 A
116-4660-016.0001	DC/DC converter MINI-PS 12-24 DC / 24 DC1	12-24 VDC / 1 A
116-4660-055.0001	DC/DC converter SD150B	24 VDC / 6,3 A
116-8147-015.5120	Converter	110-130 VAC / 220 VAC – 200 VA
116-8147-038.5130	Converter	110-130 VAC / 220 VAC – 300 VA

Relays

Part number	Description
116-7624-030.0001	Relay PLC RSC 24 DC/21, single change-over contact
116-7624-030.0002	Relay PLC RSC 24 DC/21-21, double change-over contact
116-BSX-310	Relay kit for FARE/FWRE

Surge protection

All units for mounting on TS-35 rail

Part number	Description
116-8464-210.0230	230 VAC input. PT-2PE/S-230 AC (excluding base), 1 x per 230 VAC circuit. Approved according to IEC61643-1:1998-02. Mounting width: 17.5 mm.
116-7491-080.0001	Mounting base for 230 V protection. Protection: PT-BE/FM
116-8464-215.0024	Detector loop and 20 mA communication line, UFBK-M2-PE-24 DC-ST (excluding base). 1 release unit per circuit/loop. Mounting width: 17.5 mm.
116-7491-080.0002	Mounting base for detector-loop protection UFBKE
116-7354-009.3024	Alarm circuits and 24 VDC outputs TT-SLKK5/24 AC, 1 pc. per wire (2 pcs. per circuit).
116-7354-009.3012	Alarm lines (BMA, BMF, FARE, FWRE) TT-SLKK5/12 DC, 1 x per wire

Door magnets

Image	Part number	Description
	116-6731-017.0007	Door holding magnet w/counter plate GTR048000A07, 24V / 1,6 W / 400 N
	116-6731-017.0008	Door holding magnet w/counter plate GTR063000A07, 24V / 3 W / 1000 N
	116-6731-017.0010	Robust magnetic door release w/counter plate, 50 kg, 490 N



Loop units

– a wide range covering your basic fire detection needs



We provide a wide range of loop units for our fire detection systems. Our detectors, manual call points, I/O units, control units and alarm units are developed and approved according to European directives (CPD) requiring EN 54 compliance and other appropriate worldwide regulations.







The loop units are available both with and without SelfVerify function. SelfVerify solves all issues of manual maintenance, leaving time consuming and costly physical testing redundant. With AutoSafe SelfVerify®, the system checks all detectors, interfaces, connections and cables – from detector chamber to alarm output – every single day.

Not only does the system test whether a detector is capable of provoking an alarm, it even verifies the sensitivity of every detector with a calibrated signal. The SelfVerify system ensures that each detector always responds to the correct alarm level. In the event of irregularities, the display on the operating panel will accurately pinpoint the source of any problem.



SelfVerify ensures that you have the safest and most reliable fire safety system available – a system ensuring optimal detection.

Input and output units

We offer a wide range of input and output units for many different applications. The system features Exn, Exia and Exd approved input and output units for high risk applications. All input and output units feature automatic addressing and short-circuit protection.

Image	Part number	Description	Configurable input	Monitored input	Monitored output	Inputs/outputs	Requires external PSU	SelfVerify	For AutoSafe only	For use in EX areas	Ingress Protection level*	Notes
	116-BN-180	AutoKeeper							•	•	IP30	Use two units to access one loop from two loop controllers. DIN rail mounting in cabinet.
	116-BN-201	Monitoring unit	•	•		1/0					IP54 IP67	For external units
	116-BN-221/01	Extinguishing control unit		•	•	2/1	•		•		IP67	
	116-BN-221/02	Output unit with 7 A relay			•	0/1	•		•		IP67	Loop controlled FAD unit
	116-BN-303	Single monitored input unit	•	•		1/0		•			IP54 IP67	Function selectable via dip switch For AutoSense aspirating detectors
	116-BN-304	Input/output unit	•	•		1/1		•			IP54 IP67	Function selectable via dip switch

*: When two degrees of protection is given, the lowest is relevant when using the included glands. To achieve the highest, special IP67 glands must be ordered (see page 38)

Image	Part number	Description	Configurable input	Monitored input	Monitored output	Inputs/outputs	Requires external PSU	SelfVerify	For AutoSafe only	For use in EX areas	Ingress Protection level*	Notes
	116-BN-305	Dual monitored input/output unit	•	•		2/2		•			IP54 IP67	Function selectable via dip switch For FireRay beam detectors
	116-BN-307	Monitored Fire Alarm Device Control Unit			•	0/1	•	•			IP54 IP67	
	116-BN-320	Interface unit	•	•		2/1		•			IP54 IP67	
	116-BN-320/2	Door control unit			•	2/1		•			IP54 IP67	
	116-BN-320/4	Standard control unit			•	2/1		•			IP54 IP67	Control of external equipment
	116-BN-320/5	Monitoring unit			•	1/0		•			IP54 IP67	For sprinklers

*: When two degrees of protection is given, the lowest is relevant when using the included glands. To achieve the highest, special IP67 glands must be ordered (see page 38)

Image	Part number	Description	Configurable input	Monitored input	Monitored output	Inputs/outputs	Requires external PSU	SelfVerify	For AutoSafe only	For use in EX areas	Ingress Protection level*	Notes
	116-BNB-330A	Loop adapter unit for conventional loops		•		1/1		•	•		IP20	Replacement unit for BNB-330 in existing AutoSafe 3 systems
	116-BNB-331	Loop adapter unit for conventional loops		•		1/1		•	•		IP20	AutoSafe ver. 4.4.1 → Autoprime ver. 2.0 →
	116-BN-500/EX	Input unit	•	•		1/0		•		•	IP54 IP67	For interfacing external units, clean contacts, alarm relays, etc. Zones 0, 1 & 2
	116-BN-500/N	Input unit	•	•		1/0		•		•	IP54 IP67	For interfacing external units, clean contacts, alarm relays, etc. Zone 2
	116-BN-505/EXD	Input unit with BNB-300	•	•		1/0		•		•	IP66	Zones 1 & 2 only

*: When two degrees of protection is given, the lowest is relevant when using the included glands. To achieve the highest, special IP67 glands must be ordered (see page 38)

Detectors

We offer a wide range of detectors for many different applications, with or without SelfVerify. The following series are available:

- 200 Series, standard interactive addressable detectors.
- 300 Series with SelfVerify, interactive addressable detectors.
- 500 Series with SelfVerify, interactive addressable detectors for use in demanding environments.

The system also offers Exn and Exia approved versions of detectors designed for use in high risk applications. S Series smoke detectors are specially designed for applications where high sensitivity is required.





Image	Part number	Heat	Smoke	MultiSensor	SelfVerify	Including base	Environmentally sealed	For use in EX areas	For EX zone 2 only	High sensitivity	Sealed unit	Wet/dry areas	Ingress Protection level	Notes
	116-BD-200M	•				•	•				•	W	IP56	For steam saunas/cold stores (-30 °C)
	116-BD-501	•			•	•	•				•	W	IP56	
	116-BD-501/EX	•			•	•	•	•			•	W	IP56	
	116-BD-501/N	•			•	•	•		•		•	W	IP56	
	116-BD-505/140EXD	•			•	•		•			•	W	IP66	60 °C, non-configurable class, explosion proof
	116-BD-505/160EXD	•			•	•		•			•	W	IP66	70 °C, non-configurable class, explosion proof
	116-BD-505/190EXD	•			•	•		•			•	W	IP66	90 °C, non-configurable class, explosion proof
	116-BDH-200	•										D	IP44D	
	116-BDH-300	•			•							D	IP44D	
	116-BDH-500/EX	•			•	•	•						IP44D	
	116-BDH-500/N	•			•	•		•					IP44D	
	116-BHH-200		•										IP44D	
	116-BHH-300		•			•							IP44D	
	116-BHH-500/EX		•			•	•	•					IP44D	
	116-BHH-500/N		•			•	•		•				IP44D	
	116-BHH-500/S		•			•	•			•			IP44D	
	116-BHH-500/S/Ex		•			•	•	•		•			IP44D	
	116-BHH-500/S/N		•			•	•		•	•			IP44D	
	116-BHH-220			•									IP44D	
	116-BHH-320			•		•							IP44D	
	116-BHH-520/EX			•		•	•	•					IP44D	
	116-BHH-520/N			•		•	•		•				IP44D	

Manual call points / release stations

AutoSafe offers a wide range of manual call points for different applications, every unit features SelfVerify. Two main series are available:







- 300 Series with SelfVerify, interactive addressable manual call points.
- 500 Series with SelfVerify, interactive addressable manual call points for use in demanding environments.

The system features Exn and Exia approved versions for high risk applications.

Image	Part number	Description	For use in EX areas	Zone 2 only	Watertight / outdoor model	Extreme environments	LED indicator	Metal connection box	Glass NOT included	Optional duty label*	Degree of protection
	116-BF-300V2	Manual call point									IP42D w/o cover IP44D w cover
	116-BF-510WP-H	Manual call point			•	•	•				IP52 w/o cover IP55 w cover
	116-BF-510WP-HM	Manual call point, cable glands pre mounted, robust mounting plate.			•	•	•				IP52 w/o cover IP55 w cover
	116-BF-500V2/EX	Manual call point	•								IP44D**
	116-BF-500V2/N	Manual call point		•					•		IP44D**

*: See "Duty tables" on page 31

** : Ingress Protection level, inner housing

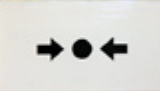
Image	Part number	Description	For use in EX areas	Zone 2 only	Watertight / outdoor model	Extreme environments	LED indicator	Metal connection box	Glass NOT included	Optional duty label*	Degree of protection
	116-BF-501	Manual call point			•	•					IP66
	116-BF-501/EX	Manual call point	•		•	•					IP66
	116-BF-501/N	Manual call point		•	•	•					IP66
	116-BF-502	Manual call point			•	•					IP66
	116-BF-502/EX	Manual call point	•		•	•					IP66
	116-BF-502/N	Manual call point		•	•	•					IP66
	116-BF-503/EX/0100	Manual call point	•		•	•			N/A		IP66
	116-BF-503/N/0100	Manual call point		•	•	•			N/A		IP66
	116-KIT-BF-503/EX/0300	Release station	•		•	•			N/A	•	IP66
	116-KIT-BF-503/N/0300	Release station		•	•	•			N/A	•	IP66
	116-KIT-BF-503/0400	Release station			•	•			N/A	•	IP66
	116-KIT-BF-503/EX/0400	Release station	•		•	•			N/A	•	IP66
	116-KIT-BF-503/N/0400	Release station		•	•	•			N/A	•	IP66
	116-KIT-BF-503/0500	Release station			•	•			N/A	•	IP66
	116-KIT-BF-503/EX/0500	Release station	•		•	•			N/A	•	IP66
	116-KIT-BF-503/N/0500	Release station		•	•	•			N/A	•	IP66
	116-BFG-3/XX	Glass for call point, available in several languages. Replace XX with country code. No ending = No text GB = English GB/AR = English and Arabic N/GB = Norwegian and English SU = Russian									





Duty lables

Part number	Text	Part number	Text
116-E-2327/1	Inergen utløsning Inergen Release	116-E-2327/26	CO2 Release station
116-E-2327/2	Brannmelder Fire alarm	116-E-2327/27	CO2 Inhibit station
116-E-2327/3	Water release	116-E-2773/1	Abandon ship
116-E-2327/4	Fire Brann	116-E-2773/2	Abandon
116-E-2327/5	Vannutløsning Water release	116-E-2773/3	Gass Gas
116-E-2327/6	Inergen press. Release	116-E-2773/4	Vanntåke
116-E-2327/7	Vannutløser Water release	116-E-2773/5	ESD 2
116-E-2327/8	Fire Monitor Water release	116-E-2773/6	CO2 release & inhibit station
116-E-2327/9	Deluge Water release	116-E-2773/7	VEEUDU KÄIVITAMINE
116-E-2327/10	Deluge release	116-E-2773/8	Argonite
116-E-2327/11	Vanntåke Water mist	116-E-2773/9	General emergency alarm
116-E-2327/12	Alarm	116-E-2773/10	Argonite Release
116-E-2327/13	Overristing Deluge	116-E-2773/11	ESD
116-E-2327/14	Start fire pumps Старт пожарный насос	116-E-2773/12	Electrical isolation
116-E-2327/15	Vanntåke Utløsning	116-E-2773/13	MCP Ручной извещатель
116-E-2327/16	Overristing	116-E-2773/14	ESD AB. OCT.
116-E-2327/17	Fire Push button	116-E-2773/15	CO2 Manual station abort
116-E-2327/18	General Alarm	116-E-2773/16	CO2 Manual station release
116-E-2327/19	FM200 release	116-E-2773/17	Manual alarm call point
116-E-2327/20	FM200 inhibit	116-E-2773/18	Exstinguishant release pushbutton
116-E-2327/21	Fire	116-E-2773/19	East monitor actuation
116-E-2327/22	Water mist release	116-E-2773/20	West monitor actuation
116-E-2327/23	Start Firewater pump	116-E-2773/21	Foam system release
116-E-2327/24	Start Foam skid	116-E-2773/22	Vannutløser Deluge release
116-E-2327/25	Clean Agent release		

*: See "Duty lables" on page 31

Control units

For the fire detection systems, Autronica offers control units for enabling and disabling of detectors, as well as daytime/nighttime units. Available in several language versions. Replace XX with country code.

Image	Part number	Description	Number of buttons	For external control	Configurable delay	For AutoSafe only	Ingress Protection level	Notes
	116-BW-200/XX	Disabling unit	2		•		IP66	Available in Swedish, English and Russian
	116-BW-201/XX	Disabling unit	0	•		•	IP66	Available in Swedish and English
	116-BW-202/XX	Daytime/Nighttime unit	2		•	•	IP66	Up to two units can be powered from detector loop. To connect more units, external 24 VDC power is required. Available in English only.
	116-BW-203/XX	Daytime/Nighttime unit	0	•		•	IP66	Up to two units can be powered from detector loop. To connect more units, external 24 VDC power is required. Available in English only.
	116-BU-200	Alarm controller unit	2			•	IP66	

Alarm units

Autronica Fire and Security offers a wide range of alarm units for mounting on detection loops or dedicated alarm outputs.





Image	Part number	Description	Alarm output mounting	Loop mounting	Electronic	Signal presets	Configurable	Watertight	Sound	Light	Sound output (dBA/1 m)	Cov.Vol.Code EN 54-23	Ingress Protection level	Notes
	116-BBL-100	Addressable alarm indicator		•						•	-	-	IP32C	
	116-BBL-100/IP	Addressable alarm indicator		•				•		•	-	-	IP65	
	116-BBR-7M	Conventional alarm bell 6"	•		•				•		93	-	IP55	
	116-BBR-24	Conventional alarm bell 6"	•						•		91	-	IP42	
	116-BBR-130	Addressable base sounder		•	•		•				90	-	IP32C	Combined detector base and addressable sounder.
	116-BBR-230	Addressable sounder		•			•		•		100	-	IP32C	

Image	Part number	Description	Alarm output mounting	Loop mounting	Electronic	Signal presets	Configurable	Watertight	Sound	Light	Sound output (dBA/1 m)	Cov.Vol.Code EN 54-23	Ingress Protection level	Notes
	116-BBR-230/IP	Addressable sounder		•			•	•	•		100	-	IP65	
	116-BBQ-130	Addressable base sounder w/ alarm indicator		•			•		•	•	90	-	IP21C	Combined detector base and addressable sounder/ alarm indicator.
	116-BBQ-230	Addressable sounder/ alarm indicator		•			•		•	•	100	-	IP32C	
	116-BBQ-230/IP	Addressable sounder/ alarm indicator		•			•	•	•	•	100	-	IP65	
	116-BU-47	Conventional alarm indicator								•	-	-	IP30	Used together with detector
	116-7770-009.0000	Askari conventional sounder	•		•	•		•	•		68-106	-	IP54	

Image	Part number	Description	Alarm output mounting	Loop mounting	Electronic	Signal presets	Configurable	Watertight	Sound	Light	Sound output (dBA/1 m)	Cov.Vol.Code EN 54-23	Ingress Protection level	Notes
	116-7770-009.0001	Askari conventional sounder	•		•	•		•	•		68-106	-	IP54	
	116-7770-009.0002	Roshni LP conventional sounder, shallow base	•		•	•		•	•		102	-	IP54	
	116-7770-009.0004	Roshni LP conventional sounder, shallow base	•		•	•		•	•		102	-	IP54	
	116-7770-009.0005	Roshni conventional sounder, deep base	•		•	•		•	•		102	-	IP65	
	116-7780-004.0001	Flashni conventional sounder/beacon, shallow base	•			•		•	•	•	101	-	IP54	
	116-7780-004.0002	Flashni conventional sounder/beacon, deep base	•			•		•	•	•	101	-	IP65	





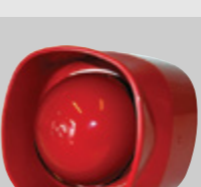

Image	Part number	Description	Alarm output mounting	Loop mounting	Electronic	Signal presets	Configurable	Watertight	Sound	Light	Sound output (dBA/1 m)	Cov.Vol.Code EN 54-23	Ingress Protection level	Notes
	116-7780-004.0004	Flashni conventional sounder/beacon, shallow base	•			•		•	•	•	101	-	IP54	For Qatar only
	116-4340-003.4001	Signal light BLG-LED	•		•	•	•	•		•	-	-	IP67	
	116-4340-006.0201	Xenon conventional beacon	•		•					•	-	-	IP55	
	116-4340-006.0924	Solex conventional beacon, shallow base	•		•		•		•	•	-	-	IP54	
	116-4340-006.0925	Solex conventional beacon, deep base	•		•		•		•	•	-	-	IP54	
	116-4340-006.0926	Solex conventional beacon, shallow base	•		•		•		•	•	-	-	IP54	

Image	Part number	Description	Alarm output mounting	Loop mounting	Electronic	Signal presets	Configurable	Watertight	Sound	Light	Sound output (dBA/1 m)	Cov.Vol.Code EN 54-23	Ingress Protection level	Notes
	116-4340-007.0001	Solista LX conventional beacon, wall mounted, deep base	•		•	•		•		•	-	W-2.4-7.5	IP65	Red flash
	116-4340-007.0002	Solista LX conventional beacon, ceiling mounted, shallow base	•		•	•	•			•	-	C-3-7.5	IP33C	Red flash
	116-4340-007.0005	Symphoni LX WP conventional base beacon, wall mounted	•		•	•	•	•		•	-	W-2.4-7.5	IP66	Red flash
	116-7770-009.0040	Symphoni IP66	•						•		100	-	IP66	For use with 116-4340-007.0005
	116-4340-007.0007	Solista LX wall, shallow base	•		•	•	•			•	-	C-3-7.5	IP33C	Red flash
	116-4340-007.0008	Symphony G1 LX, wall	•		•	•	•			•	100	W-2.4-7.5	IP21C	Red flash
	116-4340-007.0009	Symphony G1 LX, wall	•		•	•	•			•	100	W-2.4-7.5	IP21C	Red flash

Accessories for loop units

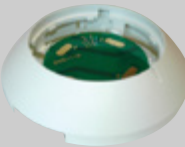



Image	Part number	Description
	116-BWA-100	Base for interactive detector heads
	116-BWB-110	Base adapter for analogue addressable detectors mounted on interactive loops
	116-BWP-100/20	Drip proof conduit box with 2 x M20 cable glands (4 x lock outs)
	116-BWP-100/25	Drip proof conduit box with 4 x lock outs for M25 glands
	116-BWP-143A	Ventilation duct adapter, for interactive systems
-	116-BJ-358/100	Pipe kit, L=100 mm
-	116-BJ-358/150	Pipe kit, L=150 mm
-	116-BJ-358/300	Pipe kit, L=300 mm
-	116-BJ-358/550	Pipe kit, L=550 mm
-	116-BJ-358/800	Pipe kit, L=800 mm
-	116-BJ-358/1000	Pipe kit, L=1000 mm
	116-BWP-145	Heated detector base
-	116-8142-983.5115	Transformer 230/48 V for up to 10 BWP-45/BWP-145
	116-BZ-500	Galvanic barrier for Exia-approved detectors, for mounting in field. If power to the unit is supplied from the panel, a 24 V DC/DC converter, e.g. 116-4660-055.0001 (page 21) must be used to regulate the power.

Image	Part number	Description
-	116-WBW-100	Bypass unit for BWA-100
-	116-WBW-101	Mounting plate for false ceilings
-	116-WBJ-140	Installation/extraction tool for AutoSafe detectors
	116-UL-050	Robust bracket for manual call points
-	116-4860-011.0100	Lift flap for manual call points BF-300V2, BF-510WP-H, BF-500V2
-	116-CXBZ	Bezel for manual call point BF-300V2, flush mounting
-	116-4860-011.9901	Key for manual call point BF-300V2 and BF-510WP-H (10 pack).
-	116-4890-021.0001	Lift flap in polycarbonate for manual call point 116-BF-502, all versions
	116-4890-018.6531	Smart Guard beskyttelsesdeksel uten lydalarm for manuelle meldere BF-300V2 og BF-510WP-H, overflatemontert
	116-4890-018.6533	Smart Guard beskyttelsesdeksel med lydalarm for manuelle meldere BF-300V2 og BF-510WP-H, overflatemontert
-	116-4890-021.0010	Lift flap in stainless steel for manual call point 116-BF-502, all versions
-	116-4890-022.0001	Lift flap in polycarbonate for manual call point 116-BF-501, all versions
-	116-4890-022.0010	Lift flap in stainless steel for manual call point 116-BF-501, all versions
-	116-BW-240	Deep mounting plate for base sounders BBR-130 and BBQ-130
-	116-6571-011.1920	Cable gland M20-1.5 for Ingress Protection level IP67 for I/O units. NB! Order with 116-6531-006.1920
-	116-6531-006.1920	Backnut for cable gland IP67. NB! Order with 116-6571-011.1920
-	116-7770-009.0008	Power base 230V for Roshni alarm unit
-	116-7870-004.0012	Timer for use with disablement unit BW-201, 2POL/16A 12 hours

Test/measuring equipment



Image	Part number	Description
	116-WBJ-5/01	Test gas dispenser for smoke detectors, excluding pole
	116-WBJ-5/02	Telescopic pole, 1,26 m to 4,5 m. 1,8 kg.
	116-WBJ-5/03	Expansion pole, 1,13 m. 0,5 kg

Image	Part number	Description
	116-WBJ-5/07	Test gas for smoke detectors, 150 ml
	116-WBJ-6/01	Heat detector test kit, battery operated, 2 x batteries and charger included (for WBJ-5/02)
	116-WBJ-10	Testfire smoke and heat detector tester kit containing: <ul style="list-style-type: none"> • 1 detector tester • 1 battery charger Solo 727 • 1 smoke capsule • 2 battery batons Solo 770
	116-WBJ-10/01	Testfire smoke and heat detector tester w/1 smoke capsule
	116-WBJ-10/02	Smoke capsule for WBJ-10 and WBJ-10/01 (6 pack)
	116-WBJ-10/03	Solo 760 battery baton 2200 mAh (spare part). Charged with Solo 726 battery charger
	116-WBJ-10/04	Solo 726 battery charger for Solo 760
	116-WBJ-10/08	Solo 770 battery baton 3000 mAh. Charged with Solo 727 battery charger.
	116-WBJ-10/09	Solo 727 battery charger for Solo 770





Detectors for special requirements

Completing your fire detection system

Some situations or applications demand a little more from the fire detection system. For these, Autronica deliver custom solutions with special detectors

Aspirating detectors function by sampling air via a network of pipes, sampled air is passed through a dust filter and into a detector chamber where the air is analysed for traces of smoke. The detectors are capable of detecting the small amounts of smoke that are generated in the initial phases of a smouldering fire, ensuring the earliest possible warning of a potential fire while distinguishing real smoke from dust and pollutants, reducing unwanted alarms to a minimum. Every detector is "trainable" for the specific environment in which it is installed. Typical applications include laboratories, large open spaces, corrosive environments, archives/historical buildings and industrial areas.

Flame detectors are especially suitable for use in connection with the general protection of large open areas where spreading of flames are expected to happen very quickly. They detect radiation from fires, the detection based on infrared radiation (IR radiation). Typical applications are large open areas, such as atria, aircraft hangars and shopping centres as well as storage rooms for flammable substances.

Beam detectors are used in large open areas instead of a quantity of point smoke detectors. The detector protects a given area by sending signals (infrared light beam) between a transmitter and receiver, and detect dimmer or changes in frequency by heat or smoke. Beam detectors are suited to applications in open spaces where costs associated with point smoke detectors would be prohibitive. Typical applications include warehouses, hotels, hospitals, schools, public buildings, etc.

Aspirating detectors

The AutoSense series are stand-alone detectors, but can also be connected to fire alarm panels. These are highly sensitive detectors with patented "artificial intelligence" (ClassiFire), which means they are able to adapt to any environment regarding optimal sensitivity, alarm limits and minimum unwanted alarms.

Image	Part number	Description	Sensitivity (obsc./m)	Max. length piping	Max. coverage (FG)	Max. coverage BS6266 (Hot Wire Test)	Sampling pipe inlets	Max. sampling holes	Alarm levels	Programming	Relays
	116-5861-018.2000	AutroSense 200	0,03–25%	200 m	2000 m ²	500 m ²	4	100	4	Man./via PC	5
	116-5861-018.1407	AutroSense Micra 10, English version	0,0015–25 %	50 m	800 m ²	50 m ²	1	10	4		2
	116-5861-018.1007	AutroSense Micra 25	0,0015–25%	25 m	450 m ²	450 m ²	1	10	1	Via PC	2
	116-5861-018.1107	AutroSense Micra 100	0,0015–25%	100 m	1600 m ²	500 m ²	2	50	1	Via PC	2

Recommended interface unit for aspirating detectors is BN-303, see "Input and output units" on page 25.

Accessories

Part number	Description
116-5861-018.2110	AutroSense command module w/o PSU
116-5861-018.4110	AutroSense Micra relay card w/inputs
116-5861-018.3051	AutroSense wire burn unit
116-5761-018.3422	AutroSense air heater
116-5861-018.9027	AutroSense 200 dust filter
116-5861-018.9028	AutroSense Micra 25 and 100 dust filter
116-5861-018.9999	Cable for "hot wire" test (roll @ 100 m)
116-XJA-030	Programming cable for AutroSense Micra
116-BW-75/06	Filter
116-BWP-144	Detector housing for sampling pipes with detector base BWA-100
116-5861-966.0009	Smoke pellets
116-5861-966.0010	Smoke matches

Piping – halogen free

Image	Part number	Description	Thickness	Colour
	116-5862-010.0050	Water hose in coil, PE50 NT10. Length: 50 meters	25 mm	Black w/blue stripe
	116-5862-010.0300	Water hose in coil, PE50 NT10. Length: 300 meters		
	116-5861-910.0027	Straight pipe L = 3 m	27 mm / 3/4"	Red
	116-5861-999.0027		27 mm / 3/4"	Grey
	116-5861-999.0025		25 mm	Red
	116-5861-999.0025W		25 mm	White
	116-5861-999.0025G		25 mm	Grey
	116-5861-914.1027	Joining socket	27 mm / 3/4"	Red
	116-5861-998.027G		27 mm / 3/4"	Grey
	116-5861-998.0025		25 mm	Red
	116-5861-998.0025W		25 mm	White
	116-5861-998.0025G		25 mm	Grey





Image	Part number	Description	Thickness	Colour
	116-5861-964.0001	T-piece	27 mm / 3/4"	Red
	116-5861-997.0027G		27 mm / 3/4"	Grey
	116-5861-997.0025		25 mm	Red
	116-5861-997.0025W		25 mm	White
	116-5861-997.0025G		25 mm	Grey
	116-5861-915.1027	Socket union	27 mm / 3/4"	Red
	116-5861-996.0027G		27 mm / 3/4"	Grey
	116-5861-996.0025		25 mm	Red
	116-5861-996.0025W		25 mm	White
	116-5861-996.0025G		25 mm	Grey
	116-5861-962.0001	Normal bend 45°	27 mm / 3/4"	Red
	116-5861-995.0027		27 mm / 3/4"	Grey
	116-5861-995.0025		25 mm	Red
	116-5861-995.0025W		25 mm	White
	116-5861-995.0025G		25 mm	Grey
	116-5861-912.0027	Normal bend 90°	27 mm / 3/4"	Red
	116-5861-994.0027G		27 mm / 3/4"	Grey
	116-5861-994.0025		25 mm	Red
	116-5861-994.0025W		25 mm	White
	116-5861-994.0025G		25 mm	Grey
	116-5861-993.0027G	90° elbow	27 mm / 3/4"	Grey
	116-5861-993.0025		25 mm	Red
	116-5861-993.0025W		25 mm	White
	116-5861-993.0025G		25 mm	Grey
	116-5861-993.0025G		25 mm	Grey
	116-5861-964.0002	End cap	27 mm / 3/4"	Red
	116-5861-992.0027G		27 mm / 3/4"	Grey
	116-5861-992.0025		25 mm	Red
	116-5861-992.0025W		25 mm	White
	116-5861-992.0025G		25 mm	Grey
	116-5861-992.0025G		25 mm	Grey
	116-5861-991.2725	Adapter 27 mm - 25 mm, female/female	-	Red
	116-5861-991.2725W			White
	116-5861-991.2725G			Grey
	116-5861-991.2725G			Grey









Image	Part number	Description	Thickness	Colour
	116-5861-965.0001	Adapter 27 mm - 25 mm, female/male	-	Red
	116-5861-964.0008	Adapter 25 mm -27 mm, female/male	-	Red
	116-5861-922.0004	T piece for capillary	27 mm / 3/4"	Red
	116-5861-989.2510		25 mm	Red
	116-5861-989.2510W		25 mm	White
	116-5861-922.0007	Discreet capillary sampling point	10 mm	Transparent
	116-5861-910.0078	Capillary tube	10 mm	Red
	116-5861-988.0010N		10 mm	Transparent
	116-5861-018.9021	Capillary sampling point kit flush	27 mm / 3/4" / 10 mm	Red
	116-5861-987.0025		25 mm / 10 mm	Red
	116-5861-987.0025N		25 mm / 10 mm	Transparent
	116-5861-935.0002	Solvent cement 250 ml w/brush	-	-



Image	Part number	Description	Thickness	Colour
	116-5861-922.0001	Test point, plane shape	-	-
	116-5861-922.0010	Sampling hole warning labels, 100 psc	-	Red
	116-5861-964.0006		Red	
	116-5861-986.2527W		White	
	116-5861-986.2527G	Pipe clip	-	Grey
	116-5861-966.0011		Transparent	
	116-5861-966.0011	Flange nut M6 for mounting clips (to fix the clips to the wall/ceiling)	-	Transparent
	116-5861-966.0001	Compression adapte	27 mm / 3/4" / 10 mm	Red
	116-5861-985.2510		25 mm / 10 mm	Red
	6-5861-966.0002	Compression adapter T	27 mm / 3/4" / 10 mm	Red
	116-5861-984.2510		25 mm / 10 mm	Red
	116-5861-966.0003	ABS test point	27 mm / 3/4"	Red
	116-5861-983.0025		25 mm	Red
	116-5861-983.0025W		25 mm	White

Image	Part number	Description	Thickness	Colour
	116-5861-966.0004	Glass condensation trap	27 mm / 3/4"	Red
	116-5861-982.0025		25 mm	Red
	116-5861-982.0025W		25 mm	White
	116-5861-966.0005	Flexible connector 30 cm	27 mm / 3/4"	Red
	116-5861-981.2530		25 mm	Red
	116-5861-981.2530W		25 mm	White
	116-5861-966.0006	Flexible connector 100 cm	27 mm / 3/4"	Red
	116-5861-981.25100		25 mm	Red
	116-5861-981.25100W		25 mm	White
	116-5861-966.0007	Condensation trap with valve	27 mm / 3/4"	Red
	116-5861-966.0008	Self bilging condensation trap	27 mm / 3/4"	Red

Flame detectors

The AutoFlame IR Flame Detector is a point flame detector for detection of fires involving combustion of carbonaceous materials. It has a high IP rating making it suitable for the harshest environments.

The dual IR flame detector is used in various applications in which risk to personnel is high and where fire might result in a large loss of equipment. Beyond critical life-safety concerns, the advanced signal processing and DYFI+ intelligence ensure that the detector has a high immunity to any nuisance alarm source and makes this detector the obvious choice for demanding applications.

Image	Part number	Description	Housing	Degree of protection	Notes
	116-BG-201	AutoFlame interactive	PCB	IP66/67	
	116-BG-21	AutoFlame conventional	PCB	IP66/67	
	116-5861-010.2010	601FEX-M IR	FR110	IP20	For indoor use only



Accessories

Image	Part number	Description
	116-KITD-BG-201F	Façade security kit containing: <ul style="list-style-type: none"> • AutoFlame BG-201 flame detector • bracket • weather baffle • connecting screws • mounting instructions Standard colour on bracket and weather protection is RAL9002 (grey-white). Other colours available on request.
	116-BG-201MRK	Replacement kit for 601F flame detector
	116-001680-001	K1003A1006 Window cleaner for flame detectors (6 pcs.)
	116-003996-001	UV/IR window cleaner kit
	116-5861-010.2013	Ex detector base for 601FEX-M flame detector
	116-5861-010.2014	Deckhead mounting kit for series 601 flame detectors

Test equipment

Image	Part number	Description
	116-006439-004	W8067S Long range test lamp (non-EX)
	116-004000-006	W867C Portable test lamp 220 V
	116-Z-TL-2056	Test lamp for function testing of BG-201/BG-21

Beam detectors

Image	Part number	Description	Detection distance	Ingress Protection level	Notes
	116-5861-023.5101	Fireray 5000-101 system Auto aligning infrared optical beam detector. 1 x detector head, 1 x system controller, 1 x reflector	5 – 50 m	IP54	
	116-5861-023.5102	Fireray 5000-102 system Auto aligning infrared optical beam detector. 1 x detector head, 1 x system controller, 4 x reflectors	50 – 100 m	IP54	
	116-5861-023.3000	Fireray 3000-101 End to end infrared optical beam smoke detector system. Transmitter, receiver and compact low-level controller.	5 – 120 m	IP54	

Recommended interface unit for Fireray aspirating detectors is BN-305, see "Input and output units" on page 25.

Accessories







Image	Part number	Description
	116-5861-023.5002	Fireray 5000-002: For 50 m – detector head and 1 x reflector
	116-5861-023.5039	Fireray 5000-03: For 100 m – detector head and 4 x reflector
	116-5861-023.5003	Fireray 5000-003: System controller
	116-5861-023.5005	Fireray 5000-005 Universal bracket for use with Fireray 5000 detector head or reflector mounting plate

Image	Part number	Description
	116-5861-023.5006	Fireray 5000-006: Surface mounting plate for 1 or 4 reflectors
	116-5861-023.5007	Fireray 5000-007: Mounting plate for 4 reflectors for use with bracket Fireray 5000-005 Image shows plate mounted on bracket, with reflector
	116-5861-023.5009	Fireray 5000-008: Mounting plate for 1 reflector for use with bracket Fireray 5000-005 Image shows plate mounted on bracket, with reflector
	116-5861-023.5010	Anti-Condensation Heater The Fireray® 5000 Anti-Condensation Heater and Bracket has been designed to be used in environmental conditions where condensation affects the operation of optical beam smoke detectors.
	116-5861-023.5011	Anti-Condensation Prism Heater and Bracket for use with Fireray® 5000 prism(s).
	116-5861-023.5008	Obscuration test filter
	116-5861-023.5004	50-100 m kit for Fireray 5000, consisting of 3 reflectors. Included in Fireray 5000-102

Image	Part number	Description
	116-5861-023.1018	Protection cage for Fireray 5000
	116-5861-023.3001	Fireray 3000-015: Pair of detectors (transmitter and receiver) for use with Fireray 3000 system
	116-5861-023.3002	Fireray 3000-201: Adjustment bracket for use with Fireray detectors

Alarmline linear heat detection

Image	Part number	Description
	116-AD68N-0001	Digital cable, 68 °C nylon, sold as yard goods up to 100 meters
	116-AD68N-0500	Digital cable, 68 °C nylon, cable bobbin of 500 meters
	116-AD88N-0001	Digital cable, 88 °C nylon, sold as yard goods up to 100 meters
	116-AD105N-0001	Digital cable, 105 °C nylon, 1 meter
	116-AD185SS-0001	Digital cable, 185°C stainless steel and nylon, 1 meter
	116-AAN-0001	Analogue LHD cable, nylon, 1 meter
	116-AACUSP	Analogue LHD control unit, self programming

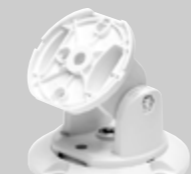
Recommended interface unit for Alarmline linear heat detectors is BN-303, see page 27.

Accessories

Part number	Description
116-5843-005.9002	Alarmline L bracket
116-5843-005.9003	Alarmline edge clip
116-5843-005.9006	Alarmline T clip, pack of 25
116-5843-005.9007	Alarmline T clip, pack of 100
116-AACU-EOL	Replacement end of line unit for use with 116-AACUSP
116-5843-007.0004	Cable ties B6782-121





AutroXT extinguishant control system

Reliable fire protection

AutroXT extinguishant control panel BA-51/1 is a standard-compliant panel that – when used together with Autronica’s interactive fire detection systems AutoSafe 4 or Autoprime – enables automatic extinguishant release in critical areas where a fire would be catastrophic, like power plants, computer rooms, switchboard rooms or engine rooms.

The extinguishant control panel has two fully monitored inputs for connection to fire detection control equipment or addressable control modules to provide an EN 12094-1 compliant extinguishant control system.

Its many programmable features and extensive range of inputs and outputs make the BA-51/1 suitable for all extinguishing applications where a fully featured control device is required.

The AutroXT extinguishant control panel BA-51/1 is connected to the AutoSafe 4 / Autoprime fire alarm control panel via two I/O units, each panel covering one zone.

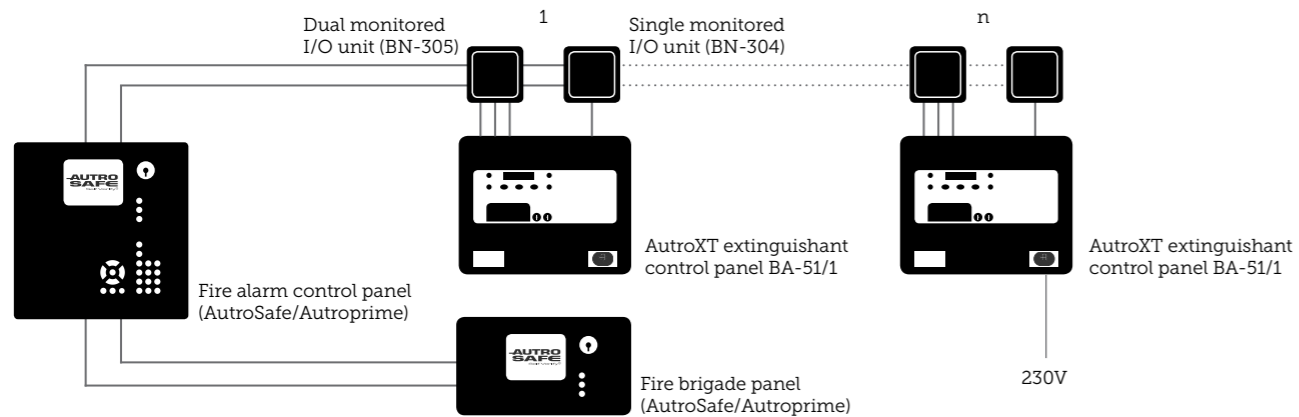

Panels

Image	Part number	Description
	116-BA-51/1/GB	Extinguishant control panel, 1 zone., English text
	116-BA-51/1/I	Extinguishant control panel, 1 zone., Italian text
	116-KITD-BA-51	Kit including extinguishant control panel BA-51/1, dual monitored input unit BN-305 and single monitored input unit BN-304. Please specify language when ordering.

Accessories

Image	Part number	Description
	116-4860-010.9008	Release station, single operation, yellow
-	116-4860-012.0100	Universal hinged cover
-	116-4860-012.0101	Breakable cover seal



AutroMaster presentation system

A fully integrated safety and emergency management system

The AutroMaster is an integrated safety and emergency management system combining the strengths of a powerful fire detection system with control and monitoring functions dedicated to make sure you are in control in case of an emergency.

The AutroMaster provides an intuitive control and monitoring interface built to save valuable time when every second counts. Status information is displayed in real-time with easy-to-understand graphical representation. Navigation is fast and instinctual and the powerful zoom functions allow you to monitor all areas in great detail.

AutroMaster displays values for gas density, smoke and heat in dynamic colours, making it easy to perform the necessary actions during emergencies.

Control and monitoring of third party systems can easily be performed via serial protocols or network interfaces. They provide connection to basically

any source – network time servers, telephone systems for text messaging, public address systems for automated voice messaging, emergency lights, access control systems, CCTV, automation systems and so on.

The AutroMaster keeps track of all events in the system and has a built-in report generator. This provides a cost-effective system log for maintenance and documentation purposes.

In high-risk environments around the world, a seemingly innocuous fire can quickly escalate into an emergency of large proportions. When disaster strikes and you only have seconds to make the proper decisions, the right safety and emergency management system is an invaluable asset. The AutroMaster includes a Decision Support System (DSS) that will help you make the right decisions at the right time.

AutroMaster V - monitoring and control made easy. A simplified solution for less complex installations.



AutroMaster editions

Modules/functions	AutroMaster V	AutroMaster 4	
		AutroMaster - onshore edition	AutroMaster - ISEMS
Basic functionality			
Fire management basic functions (AutroSafe 4, Autroprime 2.0 or later)	•	•	•
AutroSafe 3 and BS-100 interface		•	•
MultiSensor control	•	•	•
Report generator	•	•	•
Control and monitoring of emergency lights/LLL		•	•
Extended functionality			
AutroSafe IFG unit support	•	NA	•
Dual Safety (AutroSafe 4.3 or later)		•	•
DWG direct import	•		
Night mode	•		
Decision support system/incident manager			•
Electronic plotting table			•
Training/simulation module			•
Event record and replay module			•
Video module			•
Interfaces			
NMEA interface			•
VDR output			•
MODBUS interface		•	•
ESPA 4.4.4 interface		•	•

AutroMaster V

Part number	Description
116-AM-V-BASIC-200	AutroMaster V basic 200 loop units
116-AM-V-BASIC-512	AutroMaster V basic 512 loop units
116-AM-V-BASIC-2000	AutroMaster V basic 2000 loop units
116-AM-V-BASIC-ENT	AutroMaster V basic unlimited loop units

AutroMaster 4

Part number	Description
116-PROG-AUTROMASTER-ONS	AutroMaster Onshore Edition – Provides extensive fire detection and alarm management functions. Customers have the freedom to add dedicated software modules to expand the functionality according to their needs.
116-PROG-AUTROMASTERISEMS	AutroMaster ISEMS – Provides the full range of functionality – every possible add-on module is included in this package, making it the perfect choice for demanding applications and professional customers.
116-PROG-AM-UPGRADE	Upgrade of AutroMaster to most recent version – Existing AutroMaster customers can upgrade their license to the most recent version of AutroMaster. Requires change of AutroMaster configuration data.

Software modules - AutroMaster 4

Part number	Description
116-PROG-AM-MOD-VIDEO	Video interface module
116-PROG-AM-MOD-REMOTE	Remote Connect function The Remote Connect Module enables a remote connection to AutroMaster using a server/client technology.

Engineering/Configuration

Part number	Description
116-AM-CONFIG	General configuration work on setup of AutroMaster
116-AM-CHANGE	Change of AutroMaster configuration
116-PROSJAMB	Conversion of drawings into AutroMaster format
116-PROSJAMD	Adding of detectors to drawings
116-PROSJAMDF	Adding of color fill for analogue values

Hardware

Part number	Description
116-AUTROMASTER-PC-V	PC for AutroMaster V
116-AUTROMASTER-PC-12	PC, desktop version, convertible minitower. Model subject to change without prior notice.
116-AUTROMASTER-RACKPC	19" rack mount PC
116-5151-020.0210	Industrial PC w/SSD
116-5151-020.1951	19" standard LCD monitor
116-5151-020.2405	24" widescreen LCD monitor
116-5760-050.2003	Laser printer, colour, network and USB
116-5151-017.0004	Keyboard/mouse Nordic character set
116-5151-017.0002	Keyboard - UK/English character set
116-5151-020.0400	Mouse - USB - 3 buttons
116-5151-020.0732	Network card TG-3468 10/100/1000
116-5151-020.2029	Moxa 4-port serial PCIE



AutroVoice voice alarm system

Clear and precise information

Alarm bells and sirens only provide a warning signal. They cannot give information if the situation is a drill or a real incident, type or location of incident, and what they should do.

AutroVoice provides information without the use of confusing and often frightening alarm bells and sirens. Our voice-alarm systems use PA (public address) technology to alert members of the public as to what the problem is and what action they need to take. A pleasant-yet-firm pre-recorded voice is broadcast over a speaker system – this can, if necessary, be replaced with live broadcast – giving clear and precise information to the public.

People will be able to distinguish drills or tests from real incidents. If an incident should occur, the public will be guided to the nearest available exit, at a safe distance from the incident itself.

Voice alarms can be integrated into the fire detection system or delivered as a stand-alone unit.

With our new voice alarm product ranges AutroVoice miniVES and MULTIVES we're making a technological quantum leap, launching a voice alarm spear point making us better equipped to service your needs for clear and precise alarms in any building.



AutroVoice miniVES

MiniVES is a standalone voice alarm system ideal for small-to-medium sized applications where an EN 54-16:2008 system is required.

The miniVES is a plug & play solution with all elements in place, including a built-in fire microphone, programmable contact inputs and outputs, space for 1h pre-recorded messages and slots for batteries, all fitted in a neat chassis.

The master units are equipped with Class D power amplifiers, available with 2 and 4 zone configurations. The miniVES has integral back-up power supply, a charging unit and the necessary EN54-4 circuitry for the DC back-up and batteries checker.

The miniVES is a family of independent EVAC systems which can be networked together and extended by desktop zone microphones or fire microphones via TCP/IP network, providing live announcements and background music inputs. The system is using cat5 cables for paging microphones and fibre optic redundant interlink connections between the systems.



Features:

- Meets all requirements of EN54-16
- Phased evacuation
- Fully controlled by 4,5" colour touch screen
- Impedance or loop (option) speaker monitoring
- RJ45 (TCP/ IP) socket for programming
- Industrial SD card for storage of messages and FW
- Remote management via WAN
- Unlimited number of connected Fire and Zone microphones
- Network card as an option which allows to connect any number of standalone miniVES boxes creating easy extendable, distributed Voice Evacuation System



Part number	Description
116-miniVES2001L	L 2xAB (4 lines); amp 2x160W (incl. spare amp.); 1 x audio; LCD, fireman mic.; charger; w/o batteries
116-miniVES2001LN	LN 2xAB (4 lines); amp 2x160W (inc. spare amp.); 1xaudio; LCD, fiber network card, fireman mic.; charger; w/o batteries
116-miniVES4001L	L 4xAB (8 lines); amp 2x320W (incl. spare amp.); 2 x audio; LCD, fireman mic.; charger; w/o batteries
116-miniVES4001LN	LN 4xAB (8 lines); amp 2x320W (inc. spare amp.); 1xaudio; LCD, fiber network card, fireman mic.; charger; w/o batteries
116-miniVES4002L	L 4xAB indep. (8 lines); amp. 2x320W (incl. spare amp.); 2 x audio; LCD, fireman mic.; charger; w/o batteries
116-miniVES4002LN	LN 4xAB indep. (8 lines); amp. 2x320W (inc. spare amp.); 2xaudio; LCD, fiber network card, fireman mic.; charger; w/o batteries

Microphones

Bilde	Artikkelnummer	Beskrivelse
	116-ABT-M01	ABT-M01 Analogue zone microphone 1 button
	116-ABT-M04	ABT-M04 Analogue zone microphone 4 buttons

Tilbehør

Artikkelnummer	Beskrivelse
116-19"adapter miniVES	19"-adapter miniVES

AutoVoice MULTIVES

With the MULTIVES system the possibilities are endless: It is designed for versatility and flexibility – and can be extended indefinitely.

The architecture of the MULTIVES is based on fibre optic Ethernet connections between control units and other elements of the system, making it ideal for use in extensive and complex structures, such as air terminals, oil fields and refineries, commercial centers and office complexes. It is extremely suitable for both decentralized and centralized systems.

Although the primary task of the MULTIVES system is to cooperate with the fire alarm system, automatically broadcasting fire alarm messages, the fiber optic technology for digital transmission of voice messages, can also be used for commercial messages and music. In other words, it is a complete PA system for use in your everyday business.

The functionality of the system is designed in accordance with EN 54-16 - a mandatory standard which has been applicable in Europe since 2011 - and the equivalents of which have also been implemented in many other parts of the world, including the Middle East.

The MULTIVES system comprises control devices, multi-channel amplifiers as well as fireman microphone consoles and zone microphones. The system enables digital scaling communication not only among all the elements of the system but also other integrated safety systems.

Features:

- Compliance with EN 54-16, EN 60849
- 28 global audio channels
- Max 254 units in the network
- Up to 32 GB SD flash memory dedicated for playback and recording messages (48 kHz, 16 bit)
- Maximum number of simultaneously played messages dependent on the number of loudspeaker line control cards in the system
- Intercom function between all microphones
- External audio inputs in every control units and zone microphones
- Up to 12 secured amplifiers supported
- 4 common 100 V audio buses in every Control Unit for spare amplifiers and budget solutions with maximum 4 at the same time played messages
- DSP with implemented 3 band parametric EQ on all inputs on control units, 8 band parametric EQ, delay lines, audio limiter and feedback eliminator on each of the audio outputs
- Complex control inputs / outputs and RS485 interfaces for Fire Alarm Systems and BMS integration
- 8 x 80,8 x 160 and 2 x 650 W bridgeable Class D amplifiers

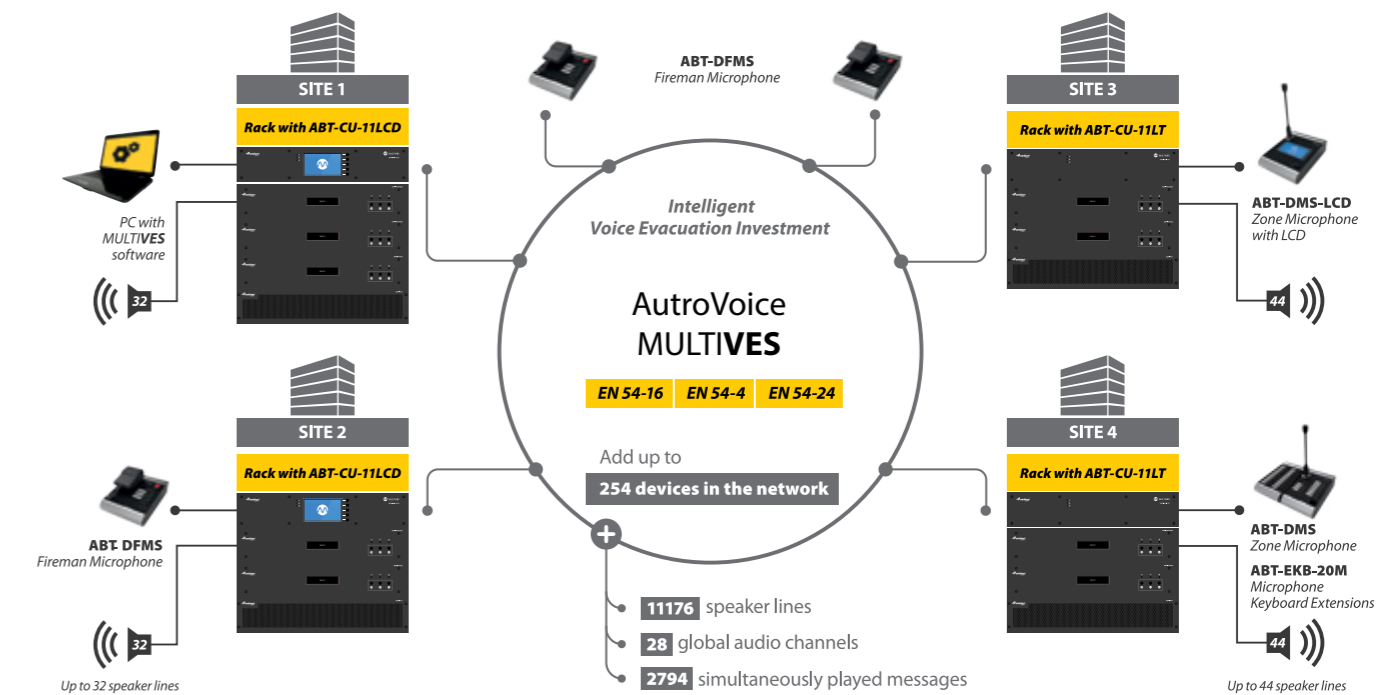

Control units

Image	Part number	Description
	116-ABT-CU-8LCD	Control Unit with LCD (8 zones)
	116-ABT-CU-11LT	Control Unit (11 zones)
	116-ABT-CU-11LCD	Control Unit with LCD (11 zones)

Control unit elements

Image	Part number	Description
	116-ABT-xNET-1Gb/WAN/RS	<p>Communication card ABT-xNET is a communication card consisting of two independent 1 GB network switches. Network switch no. 1 is destined solely for transition of data connected with the basic functionality of the MULTIVES system, i.e. working of the emergency sound system and AVB operation. Network switch no. 2 is used for remote connections.</p> <p>This card operates TCP/UDP/PTP/DHCP protocols and assures CPU-OFF based audio data exchange.</p> <p>In addition the card has an RS485 port enabling implementation and integration of the MULTIVES system with other systems. Another functionality is a POE splitter for providing power to, among others, fireman microphones.</p>
	116-ABT-xCTRLN-4	<p>4 loudspeaker line control card This card offers 4 independent loudspeaker line outlets. Measurement of the lines can be done by 2 methods: the impedance method or LOOP method. The card detects failure of the amplifier and switches the 100 V signal between internal buses and individual amplifier input on the card. A built-in dedicated measuring component on the card monitors the status of the internal rail.</p>
	116-ABT-xCTRLN-2	<p>2 loudspeaker line control card This card offers 2 independent loudspeaker line outlets (A, B). Measurement of the lines can be done by two methods: the impedance method or LOOP method. The card detects failure of the amplifier and switches the 100 V signal between internal buses and individual amplifier input on the card.</p>
	116-ABT-xAudIO-4/8-RS	<p>Function card 4 IN / 8 OUT Audio / RS-485 This card offers 4 line audio inputs via an RJ45 connector as well as 8 symmetrical outputs via an RJ45 connector for leading out audio signals to the external devices or amplifiers of the MULTIVES system. The card is also equipped with an RS485 interface with the help of which the MULTIVES system can be controlled or integrated with devices offered by other producers.</p>

Image	Part number	Description
	116-ABT-xAudI-8	<p>Function card 8 IN Audio This audio input extension card offers 8 symmetrical line audio inputs via a Phoenix-type connector.</p>
	116-ABT-xLogIN-8f	<p>8 logical inputs card (function slot) This card has 8 control inputs which may receive signals from other systems in order to trigger a desired reaction of MULTIVES system. The inputs offer two modes of work: a non-potential mode (normally shorted /normally opened) and a voltage mode. Moreover, the card monitors communication to the inputs.</p>
	116-ABT-xLogOUT-8f	<p>8 logical outputs card (function slot) The logical output card has 8 relays: 4 normally closed and 4 normally open. Each of them is fully programmable in terms of function (NC / NO) as well as function correlation.</p>
	116-ABT-xLogIN-8c	<p>8 logical inputs card (control slot) The logical input card a function or control slot has 8 control inputs which may receive signals from other systems in order to trigger a desired reaction of MULTIVES system. Inputs of an ABT-xLogIN-8f card offer two modes of work: a non-potential mode (normally shorted /normally opened) and a voltage mode. Moreover, the card monitors communication to the inputs.</p>
	116-ABT-xLogOUT-8c	<p>8 logical outputs card (control slot) The logical output card has 8 relays: 4 normally closed and 4 normally open. Each of them is fully programmable in terms of function (NC / NO) as well as function correlation.</p>

Microphones and accessories

Image	Part number	Description
	116-ABT-DFMS	Fireman's microphone
	116-ABT-DMS	Zone microphone
	116-ABT-DMS-LCD	Zone microphone with LCD
	116-ABT-EKB-20M	Microphone keyboard extension (20 buttons)
	116-ABT-ISLE	Audio / RS485 interface Communication module and audio signal splitter with RS485 for external systems integration.

Power amplifiers

We offer class-D transformer isolated power amplifiers for 50 V and 100 V distributed loudspeaker systems. They are designed for rack mounting, 2U each

In a bridged mode, amplifier channels are combined and the effect is increased.

The amplifiers have 48 VDC inputs, allowing connection to battery back-up systems for maximum availability and durability. They are powered from external power supply module ABT-PS48800 working in a block. The current from the block is distributed to individual amplifiers through the „power manager“ ABT-PSM48 (device includes a battery charger and is in compliance with EN 54-4).

Image	Part number	Description	Bridged mode
	116-ABT-PA8080B	Power amplifier D-Class 8x80 Watt	4 x 160 W
	116-ABT-PA8160B (8CH)	Power amplifier D-Class 8x160 Watt	4 x 320 W
	116-ABT-PA8160B (4CH)	Power amplifier D-Class 4x160 Watt	2 x 320 W
	116-ABT-PA2650B (2CH)	Power amplifier D-Class 2x650 Watt	1 x 1300 W
	116-ABT-PA1650B (1CH)	Power amplifier D-Class 1x650 Watt	-

Power supply modules



ABT-PSM48 power supply manager is designed for distribution of DC power supply from power supply units (PSU) and a back-up battery. The unit controls battery charging and distributes power supply to all equipment at max 60 A. When the system uses battery back-up, the power supplied is max. 3.2 kW. The unit complies with the EN 54-4 VES standards and also EN 12101-10 Smoke and Heat Control System standards.

As a main source of energy distribution, the manager uses external module ABT-PS48800: 800 W for 48 V. PSM48 power supply manager uses an internal power converter for 24 V equipment. As a source of stand-by power supply, it uses the battery bank of the capacity of up to 200 Ah.

ABT-PSM48 co-operates with the 4x12 V / 2x12 V VRLA battery bank. It maintains the bank in charged condition, ensures temperature compensation of charging parameters and monitors serial resistance of the battery and its wiring as specified in EN 54-4/A2.

ABT-PSM48 co-operates with up to 4 modules of ABT-PS4880 power supply units. The manager ensures safe connection for the purpose of parallel operations and monitors the output parameters of each power supply unit.

ABT-PS48800 is designed for assembling in a dedicated ABT-PF4 Power Supply Unit Frame. The elements of the system are designed for assembly in a 19" rack.

Image	Part number	Description
	116-ABT-PSM48	Power Supply Manager
	116-ABT-PS48800	Power Supply
	116-ABT-PF4	Power Supply Unit Frame

Modules SFP

Image	Part number	Description
–	116-SFP-1GBT-06	Module SFP Copper 1GBase-T
–	116-SF-MM31002D-GP	Module SFP, 1.25Gbps SX+ 1350nm LC DDM MMF 2km
–	116-SF-SMS31WD020D-GP	Module SFP, WDM 1.25Gbps 1310nm Tx/1550nm SC DDM SMF 20km
–	116-SF-SMS55WD020D-GP	Module SFP, WDM 1.25Gbps 1510nm Tx/1350nm SC DDM SMF 20km

Network switches

Image	Part number	Description
–	116-IFS-803GSM-8PHE24	Switch, 8xPoE, 3xSFP
–	116-IGS-402S-4PHE24	Switch, 4xPoE, 2xSFP
–	116-5151-020.0820	Switch, 8xPoE+8xLAN

Miscellaneous

Image	Part number	Description
–	116-ABT-1U	Panel 1U
–	116-ABT-2U	Panel 2U
–	116-GS18E48-P1J	Power supply for DMS 48 V, 0,375 A, 18 W

Loudspeakers

Image	Part number	Description	Max. output (W)	dB 1W/1m (SPL)	Frequency (Hz)	Dimensions (mm)	Outdoor use	HiFi	ABS plastic	Aluminium	MDF
	116-BBR-DAL 165/10 PP	Cabinet speaker, EN 54 approved	10	100,6	225 - 22 200	170 x 75				•	
	116-BBR-WAL 165/6 PP	Cabinet speaker, EN 54 approved	6	98,2	140 - 19 700	253 x 193 x 83					•
	116-BBR-DEL 130/6 PP	Ceiling speaker, EN 54 approved	6	99,2	310 - 14 800	180 x 130				•	
	116-BBR-DEL 165/6 PP	Ceiling speaker, EN 54 approved	6	100,7	380 - 22 500	220 x 110				•	
	116-BBR-DAW 130/10 PP	Projector speaker	10	94,3	125 - 20 000	140 x 200				•	
	116-BBR-DAW-K 130/10 PP	Projector speaker	10	100,2	220 - 15 600	140 x 200				•	
	116-BBR-DK-10/T PP	Horn speaker, EN 54 approved	10	106	380 - 9 000	142 x 207	•		•		
	116-BBR-DK-15/T PP	Horn speaker, EN 54 approved	15	108	460 - 9 000	208 x 272	•		•		
	116-BBR-DK-30/T PP	Horn speaker, EN 54 approved	30	110	400 - 7 500	238 x 302	•		•		
	116-BBR-DKMH30/T+EN54	Music horn speaker, EN 54 approved	30	110,1	80 - 14 000	370 x 255 x 291	•		•		



Autronica Fire and Security is a leading innovator, manufacturer and supplier of fire and gas safety worldwide. Our products ensure safety in applications on land, sea and in the petrochemical, oil and gas sectors.

Owned by United Technologies Corporation (UTC), we employ almost 450 people handling the complete value chain, from idea, development and manufacturing to the marketing, sales and servicing of our products. We are an international company with worldwide offices and our HQ is located in Trondheim, Norway's technology hotspot.

Zero loss of lives, no injuries or damages caused by fire and gas.

www.autronicafire.com

Autronica Fire and Security AS
Bromstadvegen 59, NO-7047 Trondheim, Norway | Tel: +47 90 90 55 00
info@autronicafire.no | www.autronicafire.com

Org.no.: NO 979 975 503 (MVA/VAT)